



T-1 LIGHTING

Project	Catalog #
Distributor	Type
Prepared by	Date

IGNITE

90° OPTICS LED HIGH BAY LIGHT

T1-IHBLED-MD

The **T1-IHBLED Optics MD** series is part of the Ignite family of High Bay lighting that uses an optic lens to direct light at a 90° angle and is ideal for any industrial, commercial, or high ceiling retail facility. Highly efficient and meets DLC premium standards, it is available in 2 and 4 feet models in a variety of power options, and can be customized with motion sensors, battery pack, step-down, and other accessories.

SPECS

Model Number	Input Power	Color Temp	Input Voltage	Lumens	Efficacy	Temp	CRI
T1-IHBLED2/U/201-40-MD	201	40	Standard 120-277V	30552	154	-40°C ~ +40°C -40°F ~ +104°F	>80
T1-IHBLED2/U/201-50-MD		50		30954	154		
T1-IHBLED4/U/281-40-MD	281	40		43555	155		
T1-IHBLED4/U/281-50-MD		50		44679	159		
T1-IHBLED4/U/321-40-MD	321	40	High Voltage 480V Optional	49434	154		
T1-IHBLED4/U/321-50-MD		50		50397	157		
T1-IHBLED4/U/481-40-MD	481	40		74555	155		
T1-IHBLED4/U/481-50-MD		50		76479	159		

WARRANTY: SEVEN YEAR PARTS AND FIVE YEAR LABOR



SERIES	FORM	WATTAGE	COLOR TEMP.	LENS	SENSOR	BATTERY BACKUP	ACCESSORIES	STEP-DOWN
T1-IHBLED	2	/U/ 201	50	MD	MS	EM	AC	SD
T1-IHBLED	2 2ft. 4 4ft.	201 201W 281 281W 321 321W 481 481W	40 4000K 50 5000K	MD 90°	[Blank] MS None Motion Sensor	[Blank] EM None Emergency Battery Backup	[Blank] WG AC PK None Wire Guard Aircraft Cables Pendant Mount Kit	[Blank] SD 120-277 480V

ORDERING
OPTIONS



T-1 LIGHTING

IGNITE
90° OPTICS
LED HIGH BAY LIGHT
T1-IHBLED-MD

DIMENSIONS

2ft. 201W

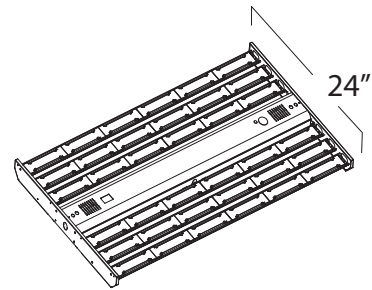
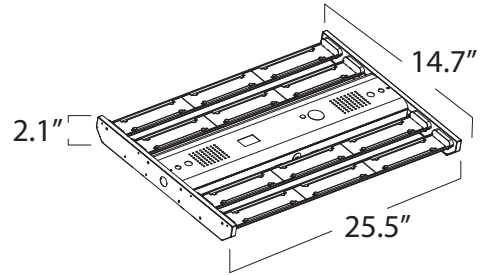
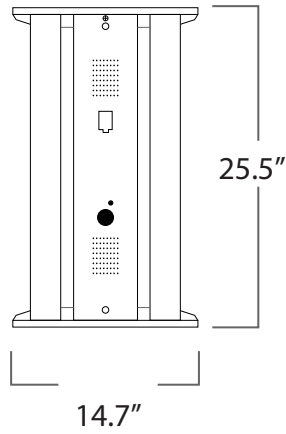

4ft. 281W

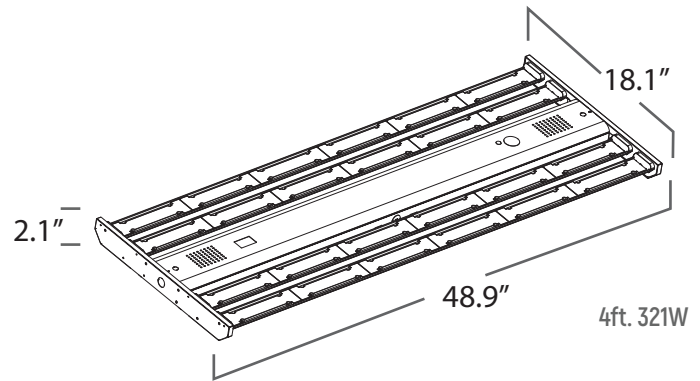
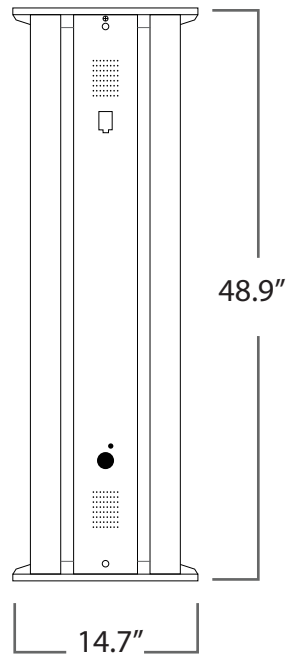

4ft. 321W

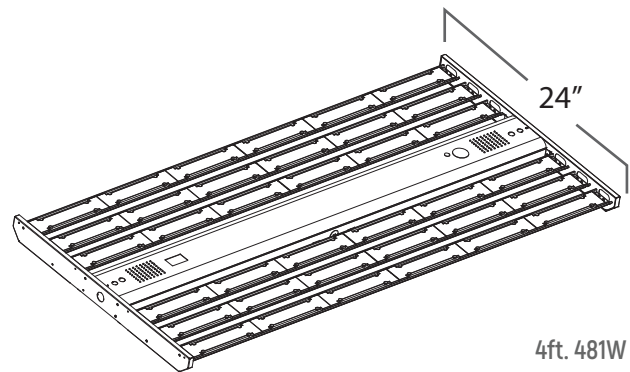

4ft. 481W



T-1 LIGHTING

IGNITE 90° OPTICS LED HIGH BAY LIGHT T1-IHBLD-MD

ACCESSORIES



V-Hook and Chain
(Included)



Aircraft Cable

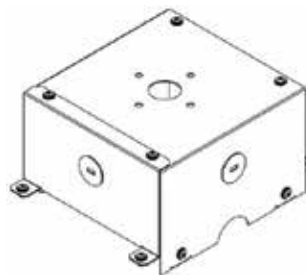

Perdent Mount Kit

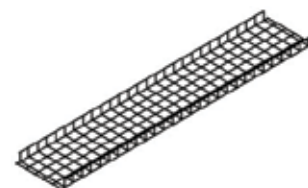

Wire Guard



Lens / Cover

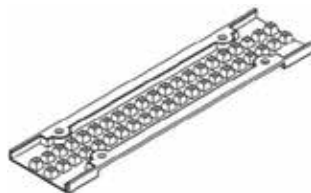

Optics

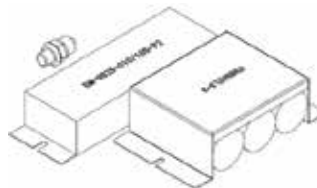

Backup Battery Pack



Motion Sensor
(Internal/External)

PHOTOMETRIC DATA 201W

Application:
Aisle or rack at low to high
mounting heights.

Beam Distribution:
90°

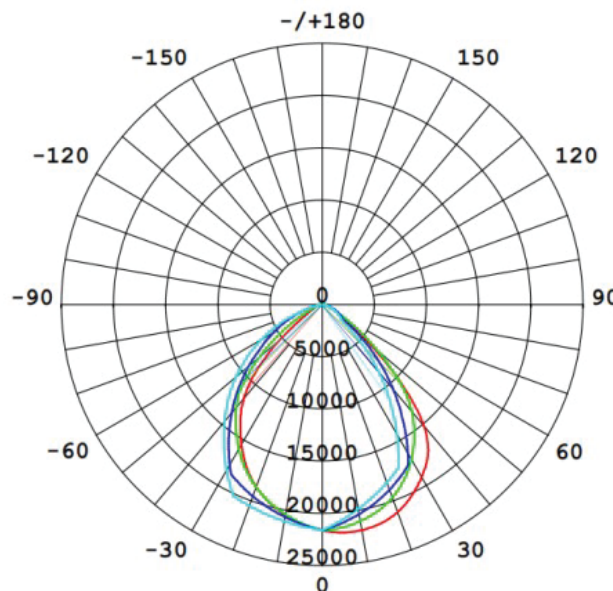

PHOTOMETRIC DATA

PHOTOMETRIC DATA 281W

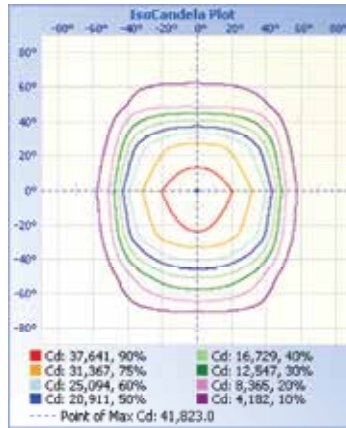
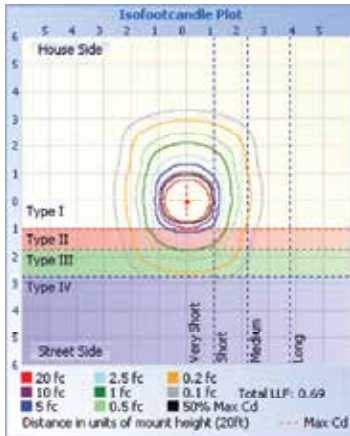

	Center Beam Fc	Beam Width
17.0ft	145 fc	29.8 ft 31.7 ft
34.0ft	36.2 fc	59.7 ft 63.4 ft
51.0ft	16.1 fc	89.5 ft 95.1 ft
68.0ft	9.04 fc	119.4 ft 126.8 ft
85.0ft	5.79 fc	149.2 ft 158.6 ft
102.0ft	4.02 fc	179.1 ft 190.3 ft

Vert. Spread: 82.5°
 Horiz. Spread: 86.0°

PHOTOMETRIC DATA 321W

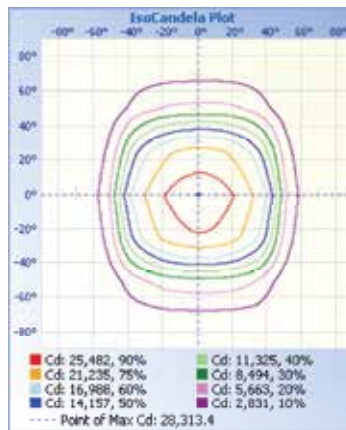
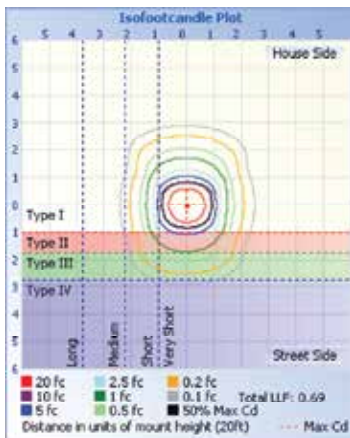

	Center Beam Fc	Beam Width
17.0ft	98.0 fc	28.0 ft 31.5 ft
34.0ft	24.5 fc	55.9 ft 62.9 ft
51.0ft	10.9 fc	83.9 ft 94.4 ft
68.0ft	6.12 fc	111.9 ft 125.9 ft
85.0ft	3.92 fc	139.8 ft 157.4 ft
102.0ft	2.72 fc	167.8 ft 188.0 ft

Vert. Spread: 79.9°
 Horiz. Spread: 85.6°

PHOTOMETRIC DATA 481W

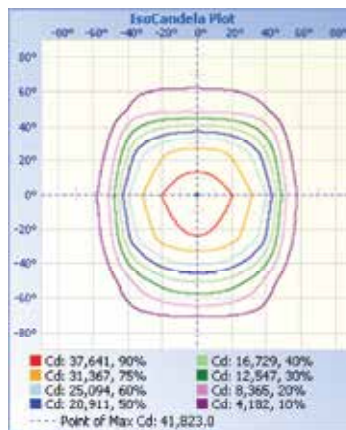
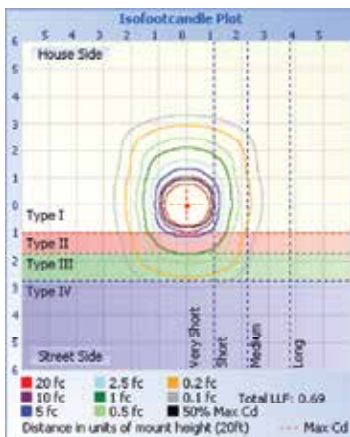

	Center Beam Fc	Beam Width
17.0ft	145 fc	29.8 ft 31.7 ft
34.0ft	36.2 fc	59.7 ft 63.4 ft
51.0ft	16.1 fc	89.5 ft 95.1 ft
68.0ft	9.04 fc	119.4 ft 126.8 ft
85.0ft	5.79 fc	149.2 ft 158.6 ft
102.0ft	4.02 fc	179.1 ft 190.3 ft

Vert. Spread: 82.5°
 Horiz. Spread: 86.0°

PHOTOMETRIC DATA